

KENWOOD



KFC-4675 DOOR/REAR DECK SPEAKER

- 4×6in 2-WAY SPEAKER
- PEAK POWER 60 Watts
- DIGITAL READY

FREQUENCY RESPONSE

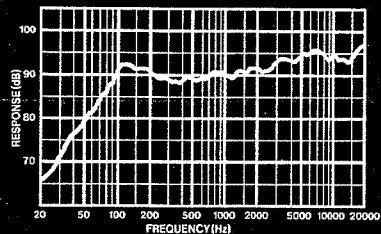

SPECIFICATIONS

Speakers	
Woofer	95×153mm(4×6in) Injection P.P.Cone Type
Tweeter	25mm(1in) P.P.T.A. Balanced Dome Type
Peak Power	60 Watts
Frequency Response	50 Hz~25,000 Hz
Sensitivity	90 dB/W at 1m
Impedance	4 Ohms
Net Weight With Grille	890g(2.0 lb)/Pair



1Pair

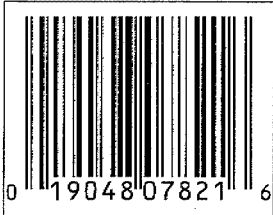

DOOR/REAR DECK SPEAKER
KFC-4675
 INSTALLATION INSTRUCTIONS

Speaker location
 Emplacement des haut-parleurs
 Platzierung der Lautsprecher
 Plaats van luidspreker
 Luogo di installazione dei altoparlanti
 Ubicación de los altavoces

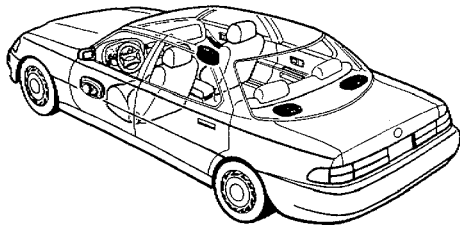

Dimensions
 Abmessungen
 Dimensioni

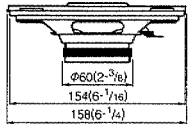
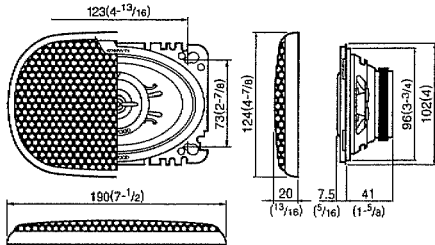

Unit:mm(inch)

TEMPLATE GABARIT SCHABLONE SJABLOON MASCHERINA PLANTILLA

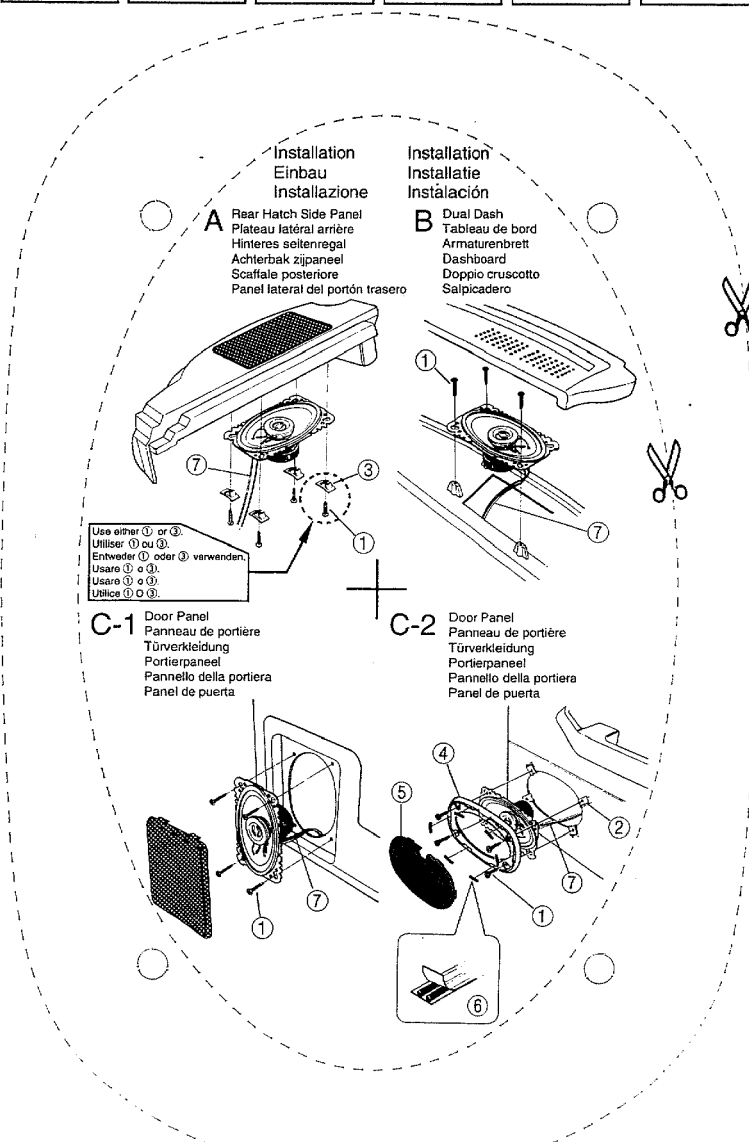

Installation Einbau Installazione
 Installation Installatie Instalación

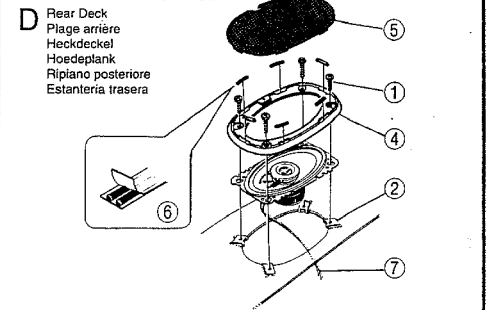

Connections
 Raccordements
 Anschlüsse
 Aansluitingen
 Collegamenti
 Conexiones

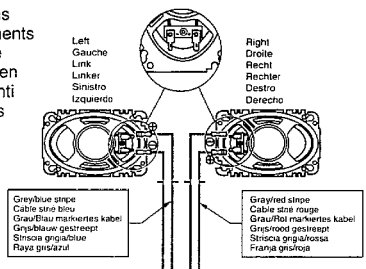

CAR AUDIO COMPONENTS
 ELEMENTS HIFI POUR VOITURE
 AUTO STEREO KOMPONENTEN
 AUTO STEREO KOMPONENTEN
 COMPONENTI AUDIO PER AUTO
 COMPONENTES DE AUDIO PARA AUTOMOVILES

- Parts included
 Mitgeliefertes zubehör
 Parti incluse
- Pieces comprises
 Bijgeleverde onderdelen
 Partes incluidas
- ① 04x25x8
 - ②x8
 - ③x8
 - ④x2
 - ⑤x2
 - ⑥x1
 - ⑦ 3m(10ft)x2

■ Do not use the provided speaker cords for other purposes (such as a power cord). Otherwise malfunction or fire hazard could result.
 ■ Ne pas utiliser les cordons de liaison aux enceintes pour une destination autre que celle prévue (par exemple, pour alimenter un appareil). Faute de quoi, un défaut de fonctionnement ou un incendie pourraient en résulter.
 ■ Die mitgelieferten Lautsprecherkabel dürfen nicht für andere Zwecke verwendet werden (z.B. als Netzkabel), da dies eine Funktionsstörung oder die Gefahr eines Brandes verursacht.
 ■ Gebruik de bijgeleverde luidsprekersnoeren niet voor andere doeleinden (bijvoorbeeld als netsnoer), daar dat mogelijk brand of andere problemen veroorzaakt.
 ■ Non utilizzare i cavi dei diffusori in dotazione per scopi diversi (come, ad esempio, cavi di alimentazione). In caso contrario si possono causare incendi e folgorazioni.
 ■ No utilice los cables de altavoces suministrados para otros propósitos (tales como los de un cable de alimentación). Si no, podrían producirse averías o peligros de incendio.